

ANCHORLIFT®

ANCHORLIFT®

WORLD CLASS WINDLASS SYSTEMS

CONTROL UNITS

WINDLASSES

ANCHORS

ROLLERS

CHAIN











HOVDAN-POLY A/S

Vi tar forbehold om endringer av spesifikasjoner,
trykkfeil og lagerkapasitet



ANCHORLIFT®

	Mtr.	5.5	6.5	8	9.5	10.5	12	16.5	20	25
	Ft.	17	20	25	29	31	36	50	60	80
	Kgs.	1 000	1 500	3 000	5 000	8 000	10 000	15 000	25 000	50 000
	Lbs.	2 200	3 300	6 600	11 000	17 600	22 000	33 000	55 500	110 000
Barracuda 500 - 600										
Barracuda 700 - 900										
Stingray 500 - 700										
Stingray 700 - 900										
Dolphin 1000										
Mako 1200										
Mako 1500										
Aquarius 2500										

Please note!

When selecting a windlass system there are a few things to consider. Such as: The size of the boat, displacement and windage, the weight of the anchor along with chain only or rope/chain combinations. All of these things must be included when selecting a windlass system.

Horizontal windlasses

Stingray 600 & 900 windlasses. All above deck models favoured by boaters with lack of height underneath deck. The rod takes a 90° turn around the gypsy and feeds directly into the anchor locker.

Vertical windlasses

Barracuda, Dolphin & the Mako series are all vertical windlasses (vertically mounted shaft) with gear and motor well hidden under deck. The anchor rod takes a 180° turn around the gypsy to ensure no hassle operation. Vertical windlasses require a higher drop of rode into the anchor locker than horizontal windlasses.

What size

Choosing a windlass too small for your boat could result in compromising your safety and inevitably result in costly repairs. This selection guide serves as

a basic guide to help you choose the right windlass for your boat. The boat's weight, windage and anchoring conditions must be considered when choosing the windlass. Remember it is better to have too much power than too little.

Using the capstan

The capstan mounted on top of the gypsy is made for warping operations. Easy clutch out power from the gypsy and capstan can be used as a separate power block. Raise the number two anchor rode or handle the boat in windy conditions.



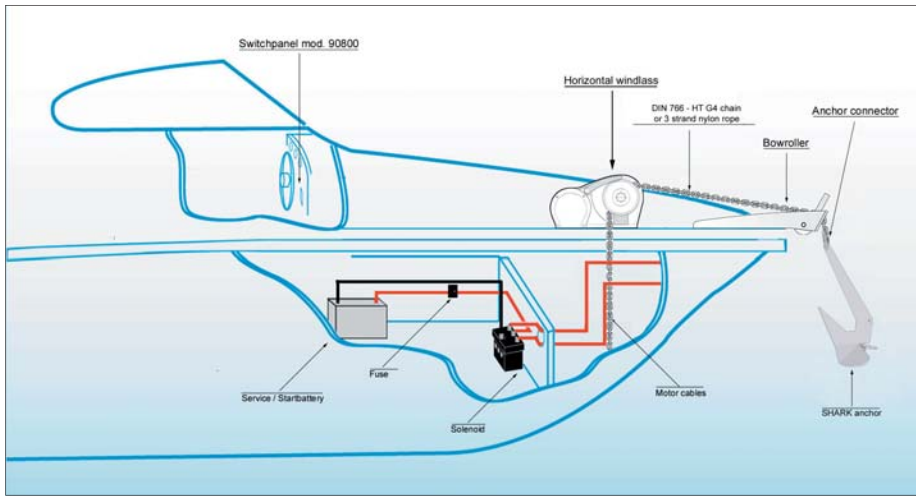

- What you need:**
 Windlass
 Bow roller
 Chain or
 Rope / Chain
 Anchor
 Anchor connector
 El. installation kit

Motorboat installation vertical windlass using the horizontal Stingray model.

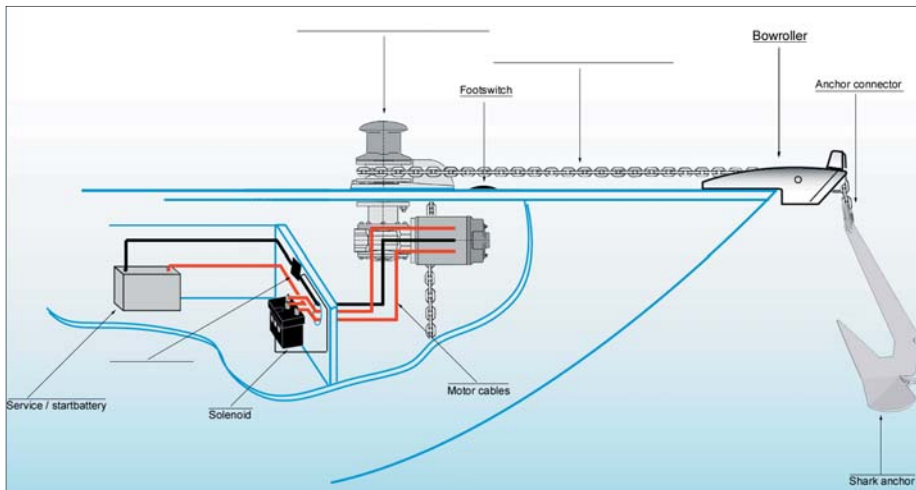

- What you need:**
 Windlass
 Bow roller
 Chain or
 Rope / Chain
 Anchor
 Anchor connector
 El. installation kit

Sailboat installation vertical windlass, capstan model with 3 wire motor

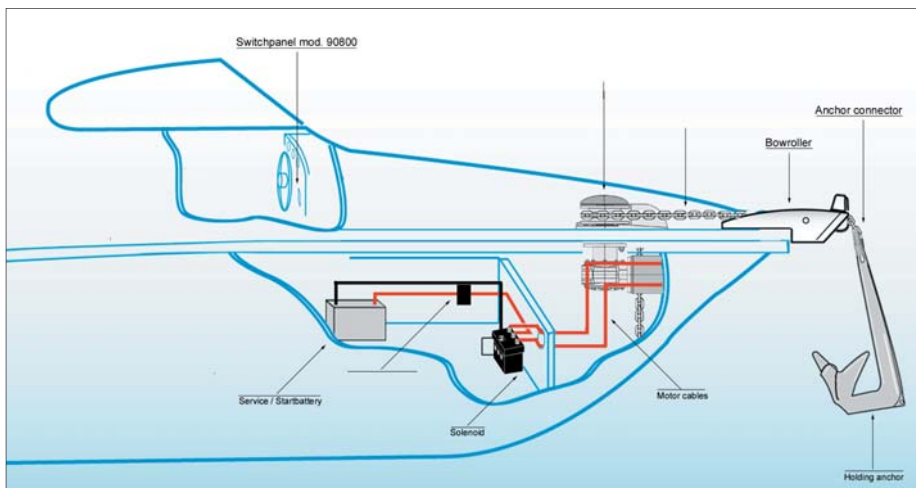

- What you need:**
 Windlass
 Bow roller
 Chain or
 Rope / Chain
 Anchor
 Anchor connector
 Electrical package

Motorboat installation vertical windlass, flush model with 2 wire motor.



Windlass selection guide. These examples are indications of what size of windlass system will fit different sizes and type of boat.



Century

Boat size: 32 ft
 Weight: 4200 kgs / 9400 lbs.
 Suggested windlass system:
 Barracuda C912 with
 Shark anchor 10 kgs / 22 lbs.
 Bow roller 90114
 El-kit EL900 and
 rope / chain combo 2007RC-250.



Bavaria

Boat size: 35 ft
 Weight: 5200 kgs / 11440 lbs.
 Suggested windlass system:
 Dolphin C1012 with
 Shark anchor 10 kgs / 22 lbs.
 Bow roller 90103
 El-kit EL1000 and
 50m / 150 ft of 8 mm - 5/16 chain



Hanse

Boat size: 45 ft
 Weight: 10 000 kgs / 12 200 lbs.
 Suggested windlass system:
 Mako 1200
 Shark anchor 15 kgs / 33 lbs.
 Bow roller 90103
 El-kit EL1200 and
 Chain 8 mm. SOMTR.



Hinckley

Boat size: 42 ft
 Weight: 10 680 kgs / 23 500 lbs.
 Suggested windlass system:
 Mako C1212C with
 Shark anchor 15 kgs / 33 lbs.
 Bow roller 90103
 El-kit EL1200 and
 50m / 150 ft of 8 mm. - 5/16 chain



Chris Craft

Boat size: 28 ft
 Weight: 3400 kgs / 7500 lbs.
 Suggested windlass system:
 Barracuda B912 with
 Shark anchor 10 kgs / 22 lbs.
 Bow roller 90103
 El-kit EL900 and
 50m / 150 ft chain/rope/chain combo



Viking 65

Boat size: 65 ft
 Weight: 50 000 kgs / 110 000 lbs.
 Suggested windlass system:
 Aquarius A2524C with
 Shark anchor 30 kgs / 66 lbs.
 Bow roller 90105
 El-kit EL2500 and
 chain only 13 mm. / 1/2 HT G4



stingray

500

Suitable for boats up to 30 ft. / 35 ft.

HIGHSPEED
WINDLASS

New lightweight composite compact all above deck windlass. Made especially for the rigid conditions of the sea. Coated seawater resistant composite material. Waterproof (IP66). A perfect choice for boaters with limited space underneath deck or with deck thickness above 50mm/2". Works with chain only or rope chain combination. Easy to install.

All Anchorlift products come with a 5 year warranty	Worldwide sales & service	Highspeed facility on all windlass models	Complete packages for perfect matching/performance	Anchorlift offer the complete windlass system
---	---------------------------	---	--	---

Part no.	121505SC512	
Motor	600 watt	
Voltage	12 volt	
Max working load	180 kg / 330 lbs	
Max power pull	450 kg / 990 lbs	
Current draw	20 A.	
Drop speed chain	35 m / 105 ft	
Gypsy options		
Alt. 1 - Chain	5 - 6 mm DIN766	
Alt. 2 - Chain/rope	7 mm - 1/4 HT G4	
Alt. 3 - Chain/rope	8 mm - 5/16 HT G4	
Rope Alt. 2	12 mm - 1/2 line	
Rope Alt. 3	14 mm - 9/16 line	
Weight	8 kg - 17,5 lbs	

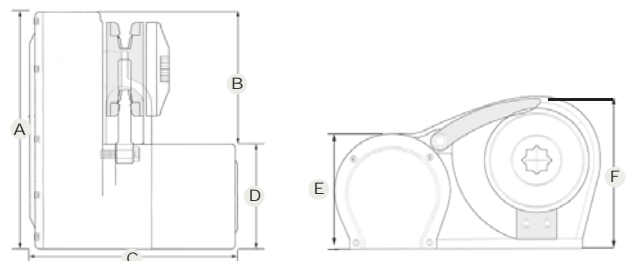

	A	B	C	D	E	F
Mm.	260	135	185	120	105	140
Inches	10,23	5,31	7,28	4,72	4,13	5,51





stingray 600 / 900

Suitable for boats up to 30 ft. / 40 ft.

HIGHSPEED
WINDLASS

New heavy duty SS Steel series. Powerful and compact all above deck windlass. Made especially for the rigid conditions of the sea. With housing made of 316 SS Steel. Waterproof (IP66). A perfect choice for boaters with limited space underneath the deck or with deck thickness above 50mm/2". Easy to install. Works with chain only or rope/chain combination.

All Anchorlift products come with a 5 year warranty	Worldwide sales & service	High speed facility on all windlass models	Complete packages for perfect matching/performance	Anchorlift offers the complete windlass system
---	---------------------------	--	--	--

Part no.	SS612	121505SS912
Motor	600 watt	900 watt
Voltage	12 volt	12 volt
Max working load	180 kg / 360lbs	300 kg / 660 lbs
Max power pull	540 kg / 1188lbs	900 kg / 1980 lbs
Current draw	20 A.	35 A.
Drop speed chain	38 m / 115 ft	38 m / 115 ft
Gypsy options		
Alt. 1 - Chain	5 - 6 mm DIN766	5 - 6 mm DIN766
Alt. 2 - Chain/rope	7 mm - 1/4 HT G4	7 mm - 1/4 HT G4
Alt. 3 - Chain/rope	8 mm - 5/16 HT G4	8 mm - 5/16 HT G4
Rope Alt. 2	12 mm - 1/2 line	12 mm - 1/2 line
Rope Alt. 3	14 mm - 9/16 line	14 mm - 9/16 line
Weight	10 kg - 22 lbs	10 kg - 22 lbs

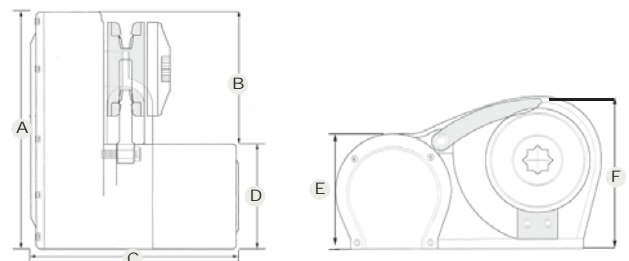

	A	B	C	D	E	F
Mm.	260	135	185	120	105	140
Inches	10,23	5,31	7,28	4,72	4,13	5,51



Barracuda

900

Suitable for boats up to 30 ft. / 35 ft.

HIGHSPEED
WINDLASS

Heavy duty SSS steel. Low profile model. Powerful and compact windlass. Vertical shaft in stainless steel. High speed drop of up to 26m/78ft./40m/120ft. Manual free fall with adjustable clutch. Parts above deck in high polished stainless steel 316. Offer long term trouble free operation. With motor/gear underneath deck offer this model a very smooth and silent operation. Works with chain only or rope/chain combination.

All Anchorlift products come with a 5 year warranty	Worldwide sales & service	High speed facility on all windlass models	Complete packages for perfect matching/performance	Anchorlift offer the complete windlass system
---	---------------------------	--	--	---

Part no.		121506B912
Motor		900 watt
Voltage		12 volt
Max working load		220 kg / 484 lbs
Max power pull		660 kg / 1452 lbs
Current draw		55 A.
Drop speed chain		40 m / 120 ft
Gypsy options		
Alt. 1 - Chain		6 mm DIN766
Alt. 2 - Chain/rope		7 mm - 1/4 HT G4
Rope Alt. 2		12 mm - 1/2 line
Weight		<15 kg - 20 lbs

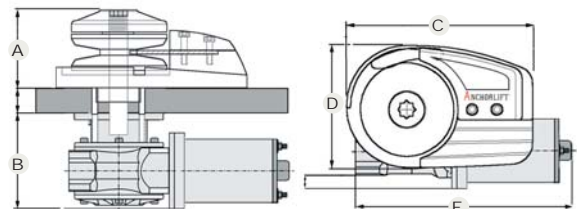

Motor gear can be mounted all 4 directions.

	A	B	C	D	E
Mm.	80	114	180	117	270
Inches	3,14	4,48	7,08	4,60	10,62



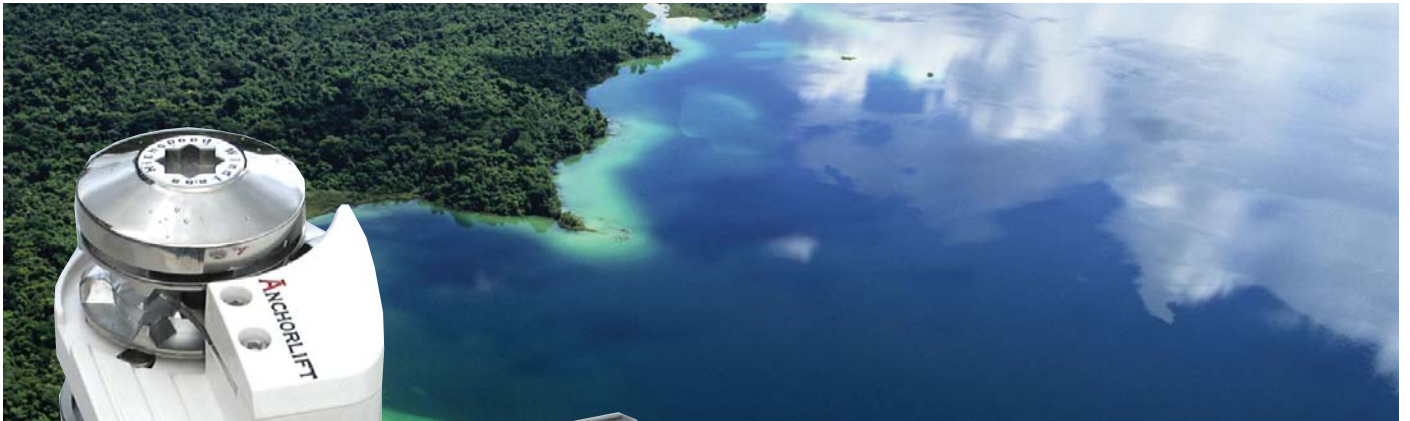

Barracuda 500 / 700

Suitable for boats up to 30 ft. / 35 ft.

HIGHSPEED
WINDLASS

New lightweight composite. Low profile powerful and compact windlass. Vertical shaft in stainless steel. High speed drop of up to 26m/78ft.-33/105ft. Manual free fall with adjustable clutch. Parts above deck in high polished stainless steel 316 and composite base. This new lightweight model offers a smooth/silent operation. Works with chain only or rope/chain combination.

All Anchorlift products come with a 5 year warranty	Worldwide sales & service	High speed facility on all windlass models	Complete packages for perfect matching/performance	Anchorlift offers the complete windlass system
---	---------------------------	--	--	--

Part no.	121506BC512	121506BC712
Motor	600 watt	900 watt
Voltage	12 volt	12 volt
Max working load	150 kg / 330 lbs	220 kg / 484 lbs
Max power pull	450 kg / 825 lbs	555 kg / 1221 lbs
Current draw	30 A.	45 A.
Drop speed chain	26 m / 78 ft	35 m / 105 ft
Gypsy options		
Alt. 1 - Chain	5 - 6 mm DIN766	5 - 6 mm DIN766
Alt. 2 - Chain/rope	7 mm - 1/4 HT G4	7 mm - 1/4 HT G4
Rope Alt. 2	12 mm - 1/2 line	12 mm - 1/2 line
Weight	7 kg - 15,5 lbs	7 kg - 15,5 lbs

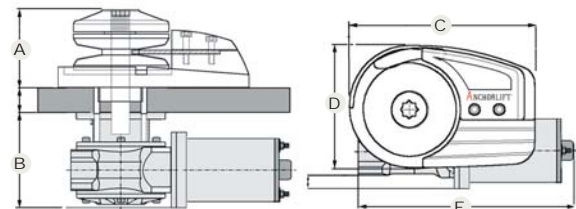

Motor gear can be mounted all 4 directions.

	A	B	C	D	E
Mm.	80	114	180	117	240
Inches	3,14	4,48	7,08	4,60	9,44



Barracuda 500 / 700

Suitable for boats up to 30 ft. / 35 ft.

HIGHSPEED
WINDLASS

New lightweight composite model. Powerful and compact windlass. Vertical shaft in stainless steel. Capstan model for optional warping operation. High speed drop of up to 26m/78ft-33m/105ft. Manual free fall with adjustable clutch. Parts above deck in stainless steel 316 and composite base. This lightweight model offers a smooth/silent operation. Works with chain only or rope/chain combination.

All Anchorlift products come with a 5 year warranty	Worldwide sales & service	High speed facility on all windlass models	Complete packages for perfect matching/performance	Anchorlift offers the complete windlass system
---	---------------------------	--	--	--

Part no.	121507BC512C	121507BC712C
Motor	600 watt	900 watt
Voltage	12 volt	12 volt
Max working load	150 kg / 330 lbs	220 kg / 484 lbs
Max power pull	375 kg / 825 lbs	555 kg / 1221 lbs
Current draw	30 A.	45 A.
Drop speed chain	26 m / 78 ft	35 m / 105 ft
Gypsy options		
Alt. 1 - Chain	5 - 6 mm DIN766	5 - 6 mm DIN766
Alt. 2 - Chain/rope	7 mm - 1/4 HT G4	7 mm - 1/4 HT G4
Rope Alt. 2	12 mm - 1/2 line	12 mm - 1/2 line
Weight	8,5 kg - 18,7 lbs	8,5 kg - 18,7 lbs

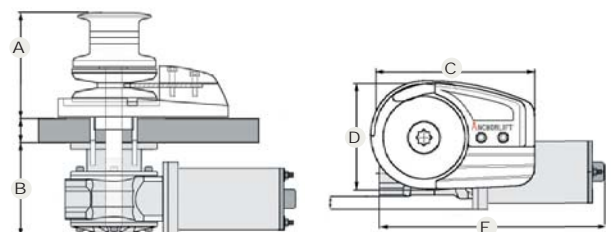

Motor gear can be mounted all 4 directions.

	A	B	C	D	E
Mm.	120	114	180	117	270
Inches	4,72	4,48	7,08	4,60	10,62



dolphin 1000

Suitable for boats 35 ft. / 45 ft.

HIGHSPEED
WINDLASS

Heavy duty SSS steel. Low profile model. Powerful windlass with a new compact motor. Vertical shaft in stainless steel. High speed drop of up to 40m / 120ft. pr. min. Manual free fall with adjustable clutch. Parts above deck in high polished stainless steel 316. Offer long term trouble free operation. With motor/gear under deck offer this model a smooth and silent operation. Works with chain only or rope/chain combination.

All Anchorlift products come with a 5 year warranty	Worldwide sales & service	High speed facility on all windlass models	Complete packages for perfect matching/performance	Anchorlift offer the complete windlass system
---	---------------------------	--	--	---

Part no.	121508D1012
Motor	1000 watt
Voltage	12 volt
Max working load	250 kg / 550 lbs
Max power pull	750 kg / 1650 lbs
Current draw	55 A.
Drop speed chain	40 m / 120 ft
Gypsy options	
Alt. 1 - Chain/rope	8 mm - 5/16 HT G4
Alt. 2 - Chain/rope	7 mm - 1/4 HT G4
Rope Alt. 1	14 mm - 9/16 line
Rope Alt. 2	12 mm - 1/2 line
Weight	20 kg - 44 lbs

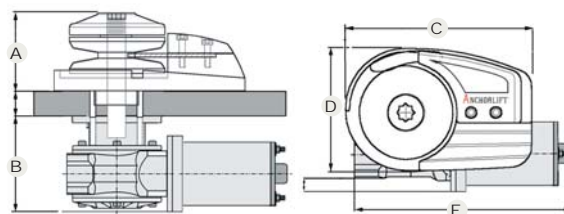

Motor gear can be mounted all 4 directions.

	A	B	C	D	E
Mm.	110	114	225	150	310
Inches	4,33	4,48	8,85	5,90	12,20



dolphin 1000

Suitable for boats 35 ft. / 45 ft.

HIGHSPEED
WINDLASS

Heavy duty SS Steel. Powerful windlass with a new compact motor. With capstan for optional warping operation. Vertical shaft in stainless steel. High speed drop of up to 40m/120ft. pr. min. Manual free fall with adjustable clutch. Parts above deck in high polished stainless steel 316. This offers long term trouble free operation. With motor/gear under deck offer this model a smooth and silent operation. Works with chain only or rope/chain combination.

All Anchorlift products come with a 5 year warranty	Worldwide sales & service	High speed facility on all windlass models	Complete packages for perfect matching/performance	Anchorlift offers the complete windlass system
---	---------------------------	--	--	--

Part no.	121509D1012C
Motor	1000 watt
Voltage	12 volt
Max working load	250 kg / 550 lbs
Max power pull	750 kg / 1650 lbs
Current draw	55 A.
Drop speed chain	40 m / 120 ft
Gypsy options	
Alt. 1 - Chain/rope	8 mm - 5/16 HT G4
Alt. 2 - Chain/rope	7 mm - 1/4 HT G4
Rope Alt. 1	14 mm - 9/16 line
Rope Alt. 2	12 mm - 1/2 line
Weight	22 kg - 48 lbs

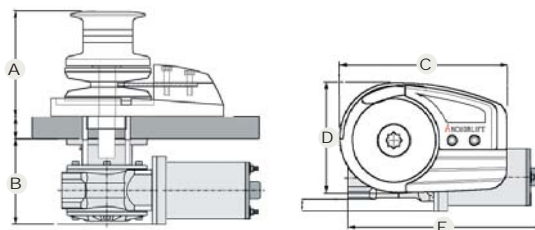

Motor gear can be mounted all 4 directions.

	A	B	C	D	E
Mm.	140	140	225	150	310
Inches	5,51	5,51	8,85	5,90	12,20



MAKO 1200 / 1500

Suitable for boats up to 40 ft. / 60 ft.

HIGHSPEED
WINDLASS

Heavy duty SSS Steel. Low profile model. Powerful 1200/1500 watt motor. Vertical shaft in stainless steel. High speed drop up to 40m/120ft. pr. min. Manual free fall with adjustable clutch. Parts above deck in high polished stainless steel 316. Offer long term trouble free operation. Available in 12 volt 1200/1500 watt or 24 volt 1500 watt. With motor/gear under deck offer this model a smooth and silent operation. Works with chain only or rope/chain combination.

All Anchorlift products come with a 5 year warranty	Worldwide sales & service	High speed facility on all windlass models	Complete packages for perfect matching/performance	Anchorlift offer the complete windlass system
---	---------------------------	--	--	---

Bestillingsvare

Part no.	121510M1212	121512M1512/M1524
Motor	1200 watt	1500 watt
Voltage	12 volt	12-24 volt
Max working load	400 kg / 800 lbs	485 kg / 1067 lbs
Max power pull	1100 kg / 2420 lbs	1200 kg / 2640 lbs
Current draw	85 A.	115-65 A.
Drop speed chain	40 m / 120 ft	40 m / 120 ft
Gypsy options		
Alt. 1 - Chain/rope	8 mm - 5/16 HT G4	10 mm - 3/8 HT G4
Alt. 2 - Chain/rope	10 mm - 3/8 HT G4	8 mm - 5/16 HT G4
Rope Alt. 1	14 mm - 9/16 line	16 mm - 5/8 line
Rope Alt. 2	16 mm - 5/8 line	14 mm - 9/16 line
Weight	25 kg / 55 lbs	25 kg / 55 lbs

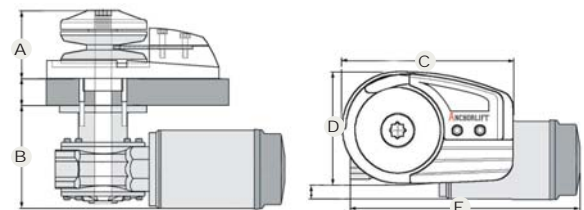

Motor gear can be mounted all 4 directions.

	A	B	C	D	E
Mm.	105	127	255	170	310
Inches	4,13	5,00	10,03	6,69	12,20



MAKO 1200 / 1500

Suitable for boats up to 40 ft. / 60 ft.

HIGHSPEED
WINDLASS

Heavy duty SS Steel. With capstan for optional warping operations. Powerful 1200/1500 watt motor. Vertical shaft in stainless steel. High speed drop of up to 40 m/120 ft. pr. min. Manual free fall with adjustable clutch. Parts above deck in high polished stainless steel 316. Offer long term trouble free operation. Available in 12 volt 1200/1500 watt or 24 volt 1500 watt. With motor/gear under deck offer this model as smooth and silent operation. Works with chain only or rope/chain combination.

All Anchorlift products come with a 5 year warranty	Worldwide sales & service	High speed facility on all windlass models	Complete packages for perfect matching/performance	Anchorlift offer the complete windlass system
Bestillingsvare				

Part no.	121511M1212C	121513M1512C/ 121513M1524C
Motor	1200 watt	1500 watt
Voltage	12 volt	12-24 volt
Max working load	400 kg / 800 lbs	485 kg / 1067 lbs
Max power pull	1100kg/2420lbs	1200 kg / 2640 lbs
Current draw	85 A.	115-65 A.
Drop speed chain	40 m / 120 ft	40 m / 120 ft
Gypsy options		
Alt. 1 - Chain/rope	8mm - 5/16 HTG4	10mm - 3/8 HTG4
Alt. 2 - Chain/rope	10mm - 3/8 HTG4	8mm - 5/16 HTG4
Rope Alt. 1	14mm - 9/16 line	16mm - 5/8 line
Rope Alt. 2	16mm - 5/8 line	14mm - 9/16 line
Weight	27 kg / 60 lbs	27 kg / 60 lbs

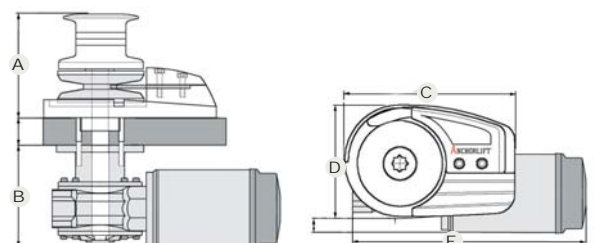

Motor gear can be mounted all 4 directions.

	A	B	C	D	E
Mm.	165	127	255	170	310
Inches	6,49	5,00	10,03	6,69	12,20



AQUARIUS 2500

Suitable for boats 55 ft. / 80 ft.

HIGHSPEED
WINDLASS

Heavy duty SSS steel. Low profile model. Extremely Powerful 2500 watt motor. Vertical shaft in stainless steel. High speed drop of up to 35m / 105ft. pr. min. Manual freefall with adjustable clutch. Parts above deck in high polished stainless steel B16. Offer long term trouble free operation. Offer different mounting options in one model.

Chain pipe can be mounted left/right of chainstripper or futher in front of windlass.
Available in 24 volt. Chain only.

All Anchorlift products come with a 5 year warranty	Worldwide sales & service	High speed facility on all windlass models	Complete packages for perfect matching / performance	Anchorlift offer the complete windlass system
---	---------------------------	--	--	---

Bestillingsvare

Part no.	121514A2524
Motor	2500 watt
Voltage	24 volt
Max working load	900 kg / 1980 lbs
Max power pull	2000 kg / 4400 lbs
Current draw	100 A.
Drop speed chain	35 m / 105 ft
Gypsy options	
Alt. 1 - Chain	10 mm - 3/8 HT G4
Alt. 2 - Chain	12/13 mm DIN766
Alt. 3 - Chain	14 mm - 1/2 HT G4
Europe DIN 766	USA HT. G4

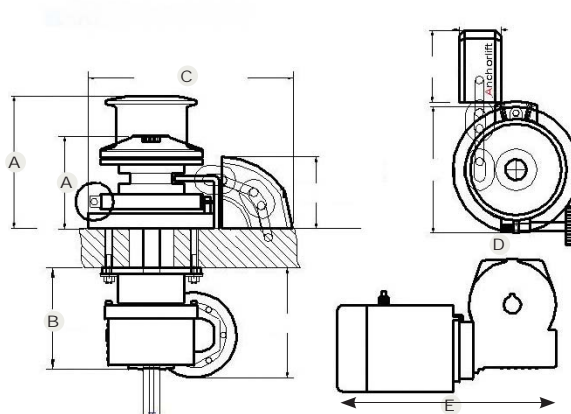

Motor gear can be mounted all 4 directions.

	A	B	C	D	E
Mm.	235	200	335	210	480
Inches	9,25	7,87	13,18	8,26	18,11



AQUARIUS 2500

Suitable for boats 55 ft. / 80 ft.

HIGHSPEED
WINDLASS

Heavy duty SS Steel Windlass. With capstan for optional warping operations. Extremely Powerful 2500 watt motor. Vertical shaft in stainless steel. High speed drop of up to 35m/105ft. pr. min. Manual free fall with adjustable clutch. Parts above deck in high polished stainless steel 316. Offer long term trouble free operation. Offer different mounting options in one model. Chain pipe can be mounted left/right of chain stripper or further in front of windlass.

Available in 24 volt. Chain only.

All Anchorlift products come with a 5 year warranty	Worldwide sales & service	High speed facility on all windlass models	Complete packages for perfect matching/performance	Anchorlift offer the complete windlass system
---	---------------------------	--	--	---

Part no.	121514A2524C
Motor	2500 watt
Voltage	24 volt
Max working load	900 kg / 1980 lbs
Max power pull	2000 kg / 4400 lbs
Current draw	100 A.
Drop speed chain	35 m / 105 ft
Gypsy options	
Alt. 1 - Chain	10 mm - 3/8 HT G4
Alt. 2 - Chain	12/13 mm DIN766
Alt. 3 - Chain	14 mm - 1/2 HT G4
Europe DIN 766	USA HT. G4

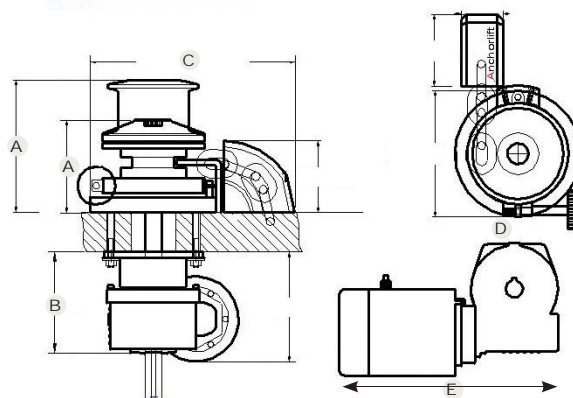

Motor gear can be mounted all 4 directions.

	A	B	C	D	E
Mm.	160	200	335	210	480
Inches	6,29	7,87	13,18	8,26	18,89

ANCHORLIFT®



SWITCH PANEL
Rockerswitch up/down function

121590800	A	B	C
Mm.	70	45	25
Inches	2,75	1,77	1,00



FOOT SWITCH
Available pair white/black

121590900	A	B	C
Mm.	75	90	25
Inches	2,75	3,54	1,00



SWITCH PANEL
Waterproof with safety switch

121590801	A	B	C
Mm.	90	57	20
Inches	3,54	2,24	0,78

Anchorlift offer a wide selection of originale electrical switch gear. This to include switch panels, circuit breaker, footswitch, solenoids and easy to install electrical mounting kit to all models. We recommend strongly use original parts for trouble free operation. 5 year warranty is available when originale parts have been used in installation. A correct electrical installation is the key for a trouble free use of the windlasses.



ELECTRICAL MOUNTING KIT
600 - 900 - 1200 - 1500 - 2500

Korrekt produkt nr. 1215 foran

EL600	EL900	EL1200	EL1500	EL2500
600	900	1200	1500	2500
500-700 Windlass	700-900 Windlass	1000-1200 Windlass	1200-1500 Windlass	2500 Windlass



RADIO RECEIVER
Four channel. Autodown function

121591354	A	B	C
Mm.	120	85	30
Inches	4,78	3,34	1,18

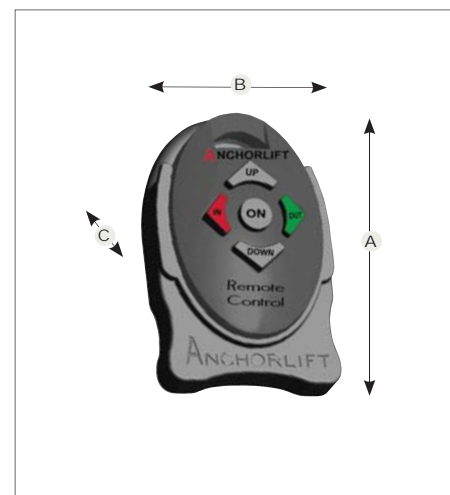

RADIO TRANSMITTER
Four channel. Autodown function

121591354	A	B	C
Mm.	75	60	30
Inches	2,95	2,36	1,18

ANCHORLIFT®



CIRCUIT BREAKER 24 volt High amp

CIRCUIT BREAKER 12 volt High amp

Korrekt produkt nr.
1215 foran

90060	90080	90100	90135	90175
60 A.	80 A.	100 A.	135 A.	175 A.
500-1000 Windlass	700-1000 Windlass	1000-1500 Windlass	1500-2000 Windlass	2500-3000 Windlass

90060	90080	90100	90135	90175
60 A.	80 A.	100 A.	135 A.	175 A.
500-700 Windlass	700-900 Windlass	900-1000 Windlass	1000-1500 Windlass	1500-2000 Windlass

Anchorlift offer a wide selection of original electrical switch gear. This includes switch panels, circuit breaker, foot switch, solenoids and easy to install electrical mounting kitsto all models. We recommend strongly to use original parts for trouble free operation. 5 year warranty is only available when original parts have been used in installation. A correct electrical installation is the key for a trouble free use of the windlasses.



Korrekt produkt nr.
1215 foran

SOLENOIDS Heavy duty Solenoid 12 volt

SOLENOIDS Heavy duty reverse Solenoids 12 volt

SOLENOIDS Heavy duty Solenoid 24 volt

121590501	A	B	C		121590503	A	B	C		90502	90504	A	B	C
12V.	130	110	70		12V.	130	110	70		24V.	24V.	130	110	70
500-1500 Windlass	5,11	4,33	2,75		500-1500 Windlass	5,11	4,33	2,75		500-1500 Windlass	1500-3000 Windlass	5,11	4,33	2,75

ANCHORLIFT®



ANCHOR CONNECTOR
Anchors 8 kg/17 lbs.-15 kg/33 lbs.

1215964408	A	B	C	D
Mm.	85	30	20	10
Inches	3,34	1,18	0,78	0,39



ANCHOR CONNECTOR
Anchor 15 kg/33 lbs.-30 kg/66 lbs.

1215964410	A	B	C	D
Mm.	95	45	25	14
Inches	3,74	1,77	0,98	0,55



ANCHOR CONNECTOR
Anchor 30 kg/66 lbs.-50 kg/110 lbs.

1215964413	A	B	C	D
Mm.	150	55	40	17
Inches	5,90	2,16	1,57	0,66

Anchorlift originale. Anchor connector made to avoid twist on chain/ropewhen launching the anchor. Made in 3 different sizes to fit anchors 6/13 lbs. to 50 kg/110 lbs. The oval shaped joint allows perfect sliding of anchor trough the bow roller with no risk of damaging the components. Each unit is quality tested and with stamped specifications. SS Steel 316.



CHAIN STOPPER
Chain 7 mm. 1/4 HT - 10 mm. 3/8 HT

121590105	A	B	C
Mm.	67	79	70
Inches	2,63	3,11	0,27



BOW ROLLER
Anchors 8 kg/18 lbs.-15 kg/33 lbs.

121590114	A	B	C
Mm.	152	146	44
Inches	5,98	5,74	1,73

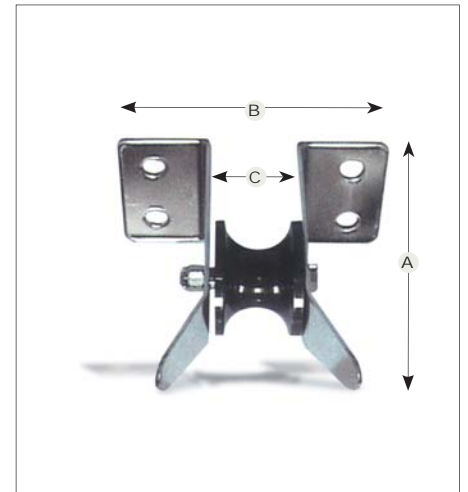

BOW ROLLER
Anchors 15 kg/33 lbs.-30 kg/66 lbs.

121590115	A	B	C
Mm.	152	190	88
Inches	5,98	7,48	3,46

Anchorlift originale. Chain stopper handles 6-10mm, 1/4-3/8 chain. Works with your bow roller to take away the tension off the windlass by locking the chain. Mounted with 4 screws to increase the breaking strenght.

ANCHORLIFT® quality bow roller made in 316 stainless steel. By mounting a bow roller it will make it easier to drop the anchor, and for the anchor to stow safe and correctly. Anchorlift bow rollers are equipped with a hinged inner roller. This gives you a self launching and self adjusting system. Works with Anchorlift Shark and Storm anchor + Bruce and Delta types.

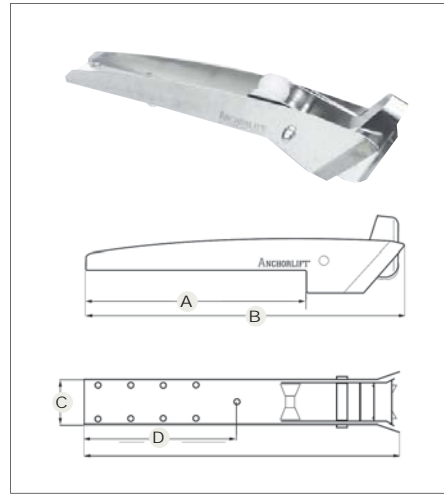
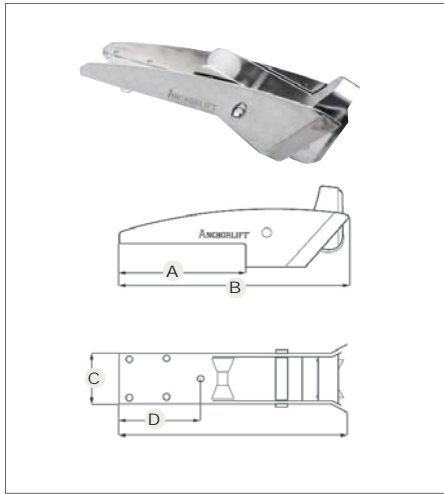

BOW ROLLER
Anchors 8 kg/17 lbs.-15 kg/33 lbs.

90102	A	B	C	D
Mm.	228	440	78	150
Inches	8,97	17,3	3,07	5,90

BOW ROLLER
Anchor 8 kg/17 lbs.-20 kg/44 lbs.

90103	A	B	C	D
Mm.	400	580	78	265
Inches	15,7	22,8	3,07	10,4

Anchor



0027050	BRUCE KOPI ANKER 5 kg Galv.	0027005	BRUCE kopi Rustfri 5kg
0027075	BRUCE KOPI ANKER 7,5 kg Galv.	0027007	BRUCE kopi Rustfri 7,5kg
0027100	BRUCE KOPI ANKER 10 kg Galv.	0027010	BRUCE kopi Rustfri 10kg
0027150	BRUCE KOPI ANKER 15 kg Galv.	0027015	BRUCE kopi Rustfri 15kg
0027200	BRUCE KOPI ANKER 20 kg Galv.	0027020	BRUCE kopi Rustfri 20kg
0027300	BRUCE KOPI ANKER 30 kg Galv.	0027030	BRUCE kopi Rustfri 30kg



Double braided anchor rope with flexible lead core and stainless steel core. Specially made for automatic winches.

Diam mm:	12	14	16
Length m:	50	50	50
Av strength kgs:	2000	2700	3800
Weight grams/m:	230	368	400
Colour:	White	White	White

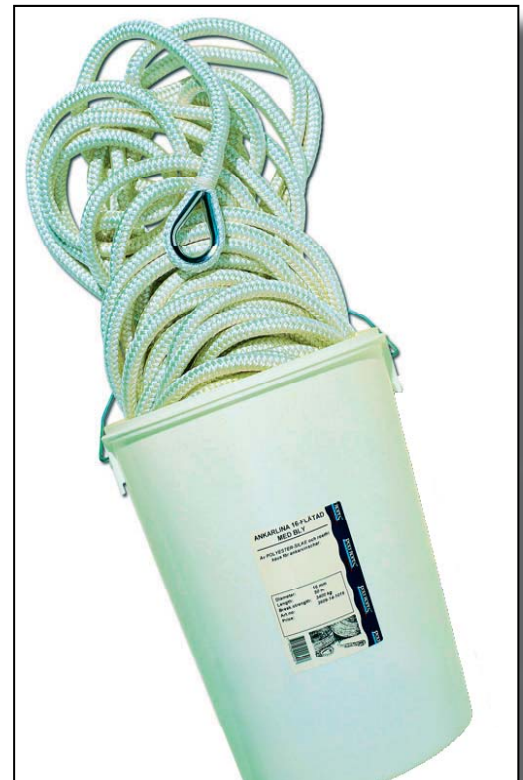

3609141012	POLY ANKERTAU m/bly flett 12mm 50m bømte C25
3609141014	POLY ANKERTAU m/bly flett 14mm 50m bømte C25
3609141016	POLY ANKERTAU m/bly flett 16mm 50m bømte C25

ANCHORLIFT®



Chain

European standard DIN 766
USA standard High tensile HT G4

Top quality hot dipped galvanized steel chain for use on Anchorlift windlasses. For the windlass to work problem free you need the correct chain, the chain has to perfectly match the gypsy for the windlass to run smoothly. Our chain is adjusted and calibrated according to DIN 766 standard for the European market. For the USA market the chain is calibrated according to standard highest G4. The chain sits itself in the windlass gypsy and the weight causes it to drop through the chain pipe. Chain is favoured by many cruising boaters, it is compact in size, highly abrasion-resistant and lies firmly on the bottom in most conditions. With the 5mm chain it is now possible for boats with weight up to 4400 lbs - 2000 kg to use chain only without putting unnecessary weight on the bow.

Why use chain

The weight of the chain helps when setting the anchor quickly on these seabed. Highly abrasion resistant, strong and lies on the bottom under most conditions. Chain stores more compact in the locker, this means that the height of the locker room is less critical. Chain works every time and will not get twisted in the locker room (to prevent occasional twisting we recommend the use of an anchor swivel connector). Due to the chain pockets on the gypsy the chain will always go down and up correctly.

The weight of the chain can on smaller boats be too heavy for the bow*. More expensive than rope. Some noise when the chain is under motion.

*(Anchorlift delivers chain down to 5mm and weighs only 0,35 lbs per Ft and this is ideal for boats up to 4400 lbs)

Chain last almost a lifetime without any problems.

Part no.	Size	Weight*	Dim**	Breaking load	Suitable for windlass
2005	5 mm.	0,52 kg - 1,18 lbs	23,5 x 12	1300 kg - 2860 lbs	600 & 900
2006	6 mm.	0,81 kg - 1,7 lbs	24,5 x 12	1800 kg - 3960 lbs	600 & 900
2007	7 mm. - ¼ HT	1,06 kg - 2,3 lbs	29 x 16	2500 kg - 5610 lbs	900 & 1000
2008	8 mm. - ⅝ HT	1,4 kg - 3,08 lbs	32 x 18	3300 kg - 7260 lbs	1000 & 1200
2010	10 mm. - ⅜ HT	2,34 kg - 5,1 lbs	38 x 24	5000 kg - 11000 lbs	1500 & 2500
2013	13 mm. - ½ HT	4,02 kg - 8,8 lbs	49 x 31	8600 kg - 18920 lbs	2500



Why choose



All Anchorlift products come with a 5 year warranty



World wide sales & service



Hightspeed facility on all windlass models



Complete packages for perfect matching/performance



Anchorlift offers the complete windlass system



ANCHORLIFT IS CONSTANTLY SEEKING WAYS OF IMPROVING PRODUCTS, DESIGNS AND SPECIFICATIONS. ALL THOUGH EVERY EFFORT IS MADE TO KEEP AN UP TO DATE LITERATURE, PRODUCTS CAN CHANGE WITHOUT NOTICE WE SENCIRELY APPOLOGIZE FOR ANY MISPELLING AND PRINT ERRORS IN THE CATALOGUE